

# NCP1400A

## 100 mA, Fixed Frequency PWM Step-Up Micropower Switching Regulator

The NCP1400A series are micropower step-up DC to DC converters that are specifically designed for powering portable equipment from one or two cell battery packs. These devices are designed to startup with a cell voltage of 0.8 V and operate down to less than 0.2 V. With only four external components, this series allows a simple means to implement highly efficient converters that are capable of up to 100 mA of output current.

Each device consists of an on-chip fixed frequency oscillator, pulse width modulation controller, phase compensated error amplifier that ensures converter stability with discontinuous mode operation, soft-start, voltage reference, driver, and power MOSFET switch with current limit protection. Additionally, a chip enable feature is provided to power down the converter for extended battery life.

The NCP1400A device series are available in the Thin SOT23-5 package with seven standard regulated output voltages. Additional voltages that range from 1.8 V to 4.9 V in 100 mV steps can be manufactured.

### Features

- Extremely Low Startup Voltage of 0.8 V
- Operation Down to Less than 0.2 V
- Only Four External Components for Simple Highly Efficient Converters
- Up to 100 mA Output Current Capability
- Fixed Frequency Pulse Width Modulation Operation
- Phase Compensated Error Amplifier for Stable Converter Operation
- Chip Enable Power Down Capability for Extended Battery Life
- Pb-Free Packages are Available

### Typical Applications

- Cellular Telephones
- Pagers
- Personal Digital Assistants
- Electronic Games
- Digital Cameras
- Camcorders
- Handheld Instruments
- White LED Torch Light



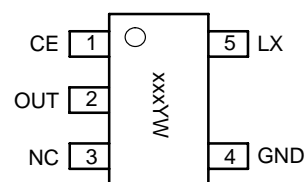
ON Semiconductor®

<http://onsemi.com>



THIN SOT23-5  
SN SUFFIX  
CASE 483

### PIN CONNECTIONS AND MARKING DIAGRAM



(Top View)

xxx = Marking

Y = Year

W = Work Week

### ORDERING INFORMATION

See detailed ordering and shipping information in the ordering information section on page 2 of this data sheet.

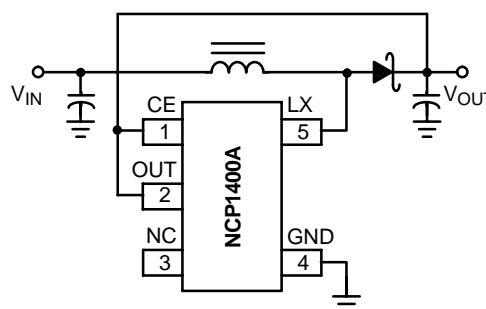


Figure 1. Typical Step-Up Converter Application

# NCP1400A

## ORDERING INFORMATION

Device	Output Voltage	Switching Frequency	Marking	Package	Shipping†
NCP1400ASN19T1	1.9 V	180 KHz	DAI	Thin SOT23-5	3000 / Tape & Reel (7 Inch Reel)
NCP1400ASN19T1G	1.9 V		DAI	Thin SOT23-5 (Pb-Free)	
NCP1400ASN22T1	2.2 V		DCN	Thin SOT23-5	
NCP1400ASN22T1G	2.2 V		DCN	Thin SOT23-5 (Pb-Free)	
NCP1400ASN25T1	2.5 V		DAV	Thin SOT23-5	
NCP1400ASN25T1G	2.5 V		DAV	Thin SOT23-5 (Pb-Free)	
NCP1400ASN27T1	2.7 V		DAA	Thin SOT23-5	
NCP1400ASN30T1	3.0 V		DAB		
NCP1400ASN33T1	3.3 V		DAJ		
NCP1400ASN38T1	3.8 V		DBK	Thin SOT23-5 (Pb-Free)	
NCP1400ASN38T1G	3.8 V		DBK		
NCP1400ASN45T1	4.5 V		DBL	Thin SOT23-5	
NCP1400ASN45T1G	4.5 V		DBL	Thin SOT23-5 (Pb-Free)	
NCP1400ASN50T1	5.0 V		DAD	Thin SOT23-5	
NCP1400ASN50T1G	5.0 V		DAD	Thin SOT23-5 (Pb-Free)	

NOTE: The ordering information lists seven standard output voltage device options. Additional devices with output voltage ranging from 1.8 V to 5.0 V in 100 mV increments can be manufactured. Contact your ON Semiconductor representative for availability.

†For information on tape and reel specifications, including part orientation and tape sizes, please refer to our Tape and Reel Packaging Specifications Brochure, BRD8011/D.

## ABSOLUTE MAXIMUM RATINGS

Rating	Symbol	Value	Unit
Power Supply Voltage (Pin 2)	$V_{OUT}$	-0.3 to 6.0	V
Input/Output Pins LX (Pin 5) LX Peak Sink Current	$V_{LX}$ $I_{LX}$	-0.3 to 6.0 400	V mA
CE (Pin 1) Input Voltage Range Input Current Range	$V_{CE}$ $I_{CE}$	-0.3 to 6.0 -150 to 150	V mA
Thermal Resistance Junction to Air	$R_{\theta JA}$	250	°C/W
Operating Ambient Temperature Range (Note 2)	$T_A$	-40 to +85	°C
Operating Junction Temperature Range	$T_J$	-40 to +125	°C
Storage Temperature Range	$T_{stg}$	-55 to +150	°C

Maximum ratings are those values beyond which device damage can occur. Maximum ratings applied to the device are individual stress limit values (not normal operating conditions) and are not valid simultaneously. If these limits are exceeded, device functional operation is not implied, damage may occur and reliability may be affected.

- This device series contains ESD protection and exceeds the following tests:  
Human Body Model (HBM)  $\pm 2.0$  kV per JEDEC standard: JESD22-A114.  
Machine Model (MM)  $\pm 200$  V per JEDEC standard: JESD22-A115.
- The maximum package power dissipation limit must not be exceeded.

$$P_D = \frac{T_{J(max)} - T_A}{R_{\theta JA}}$$

- Latchup Current Maximum Rating:  $\pm 150$  mA per JEDEC standard: JESD78.
- Moisture Sensitivity Level (MSL): 1 per IPC/JEDEC standard: J-STD-020A.

# NCP1400A

## ELECTRICAL CHARACTERISTICS (For all values $T_A = 25^\circ\text{C}$ , unless otherwise noted.)

Characteristic	Symbol	Min	Typ	Max	Unit
----------------	--------	-----	-----	-----	------

### OSCILLATOR

Frequency ( $V_{OUT} = V_{SET} \times 0.96$ , Note 5)	$f_{OSC}$	144	180	216	kHz
Frequency Temperature Coefficient ( $T_A = -40^\circ\text{C}$ to $85^\circ\text{C}$ )	$\Delta f$	–	0.11	–	%/°C
Maximum PWM Duty Cycle ( $V_{OUT} = V_{SET} \times 0.96$ )	$D_{MAX}$	68	75	82	%
Minimum Startup Voltage ( $I_O = 0$ mA)	$V_{start}$	–	0.8	0.95	V
Minimum Startup Voltage Temperature Coefficient ( $T_A = -40^\circ\text{C}$ to $85^\circ\text{C}$ )	$\Delta V_{start}$	–	–1.6	–	mV/°C
Minimum Operation Hold Voltage ( $I_O = 0$ mA)	$V_{hold}$	0.3	–	–	V
Soft–Start Time ( $V_{OUT} > 0.8$ V)	$t_{SS}$	0.5	2.0	–	ms

### LX (PIN 5)

LX Pin On–State Sink Current ( $V_{LX} = 0.4$ V) Device Suffix:	$I_{LX}$				mA
19T1		80	90	–	
22T1		80	90	–	
25T1		80	120	–	
27T1		100	125	–	
30T1		100	130	–	
33T1		100	135	–	
38T1		100	145	–	
45T1		100	155	–	
50T1		100	160	–	
Voltage Limit ( $V_{OUT} = V_{CE} = V_{SET} \times 0.96$ , $V_{LX}$ “L” Side)	$V_{LXLIM}$	0.65	0.8	1.0	V
Off–State Leakage Current ( $V_{LX} = 5.0$ V, $T_A = -40^\circ\text{C}$ to $85^\circ\text{C}$ )	$I_{LKG}$	–	0.5	1.0	μA

### CE (PIN 1)

CE Input Voltage ( $V_{OUT} = V_{SET} \times 0.96$ ) High State, Device Enabled Low State, Device Disabled	$V_{CE(high)}$ $V_{CE(low)}$	0.9 –	– –	– 0.3	V
CE Input Current (Note 6) High State, Device Enabled ( $V_{OUT} = V_{CE} = 5.0$ V) Low State, Device Disabled ( $V_{OUT} = 5.0$ V, $V_{CE} = 0$ V)	$I_{CE(high)}$ $I_{CE(low)}$	–0.5 –0.5	0 0.15	0.5 0.5	μA

5.  $V_{SET}$  means setting of output voltage.

6. CE pin is integrated with an internal 150 nA pullup current source.

# NCP1400A

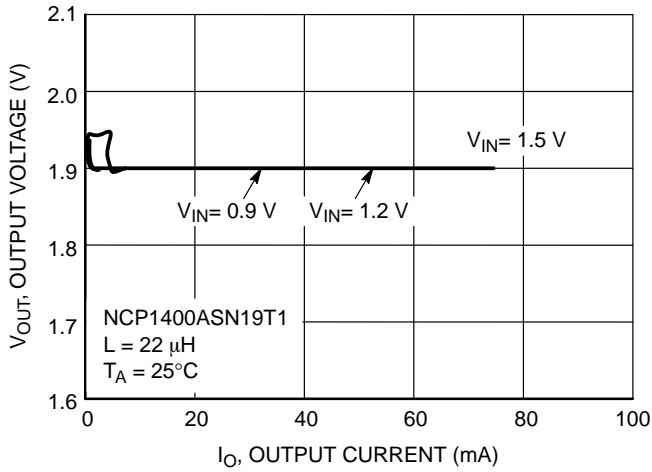
## ELECTRICAL CHARACTERISTICS (continued) (For all values $T_A = 25^\circ\text{C}$ , unless otherwise noted.)

Characteristic	Symbol	Min	Typ	Max	Unit
<b>TOTAL DEVICE</b>					
Output Voltage ( $V_{IN} = 0.7 \times V_{OUT}$ , $I_O = 10 \text{ mA}$ ) Device Suffix: 19T1 22T1 25T1 27T1 30T1 33T1 38T1 45T1 50T1	$V_{OUT}$	1.853 2.145 2.438 2.633 2.925 3.218 3.705 4.3875 4.875	1.9 2.2 2.5 2.7 3.0 3.3 3.8 4.5 5.0	1.948 2.255 2.563 2.768 3.075 3.383 3.895 4.6125 5.125	V
Output Voltage Temperature Coefficient ( $T_A = -40^\circ\text{C}$ to $+85^\circ\text{C}$ ) Device Suffix: 19T1 22T1 25T1 27T1 30T1 33T1 38T1 45T1 50T1	$\Delta V_{OUT}$	– – – – – – – – –	100 100 100 100 100 100 150 150 150	– – – – – – – – –	ppm/ $^\circ\text{C}$
Operating Current 2 ( $V_{OUT} = V_{CE} = V_{SET} + 0.5 \text{ V}$ , Note 5)	$I_{DD2}$	–	7.0	15	$\mu\text{A}$
Off-State Current ( $V_{OUT} = 5.0 \text{ V}$ , $V_{CE} = 0 \text{ V}$ , $T_A = -40^\circ\text{C}$ to $+85^\circ\text{C}$ , Note 6)	$I_{OFF}$	–	0.6	1.5	$\mu\text{A}$
Operating Current 1 ( $V_{OUT} = V_{CE} = V_{SET} \times 0.96$ , $f_{OSC} = 180 \text{ kHz}$ ) Device Suffix: 19T1 22T1 25T1 27T1 30T1 33T1 38T1 45T1 50T1	$I_{DD1}$	– – – – – – – – –	23 27 32 32 37 37 44 53 70	50 60 60 60 60 60 65 75 100	$\mu\text{A}$

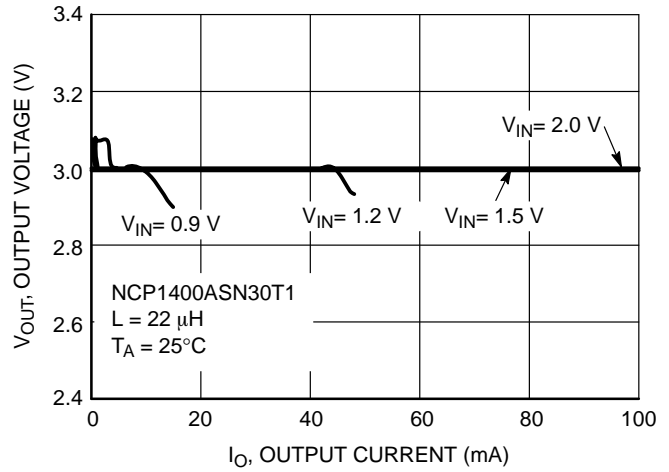
5.  $V_{SET}$  means setting of output voltage.

6. CE pin is integrated with an internal 150 nA pullup current source.

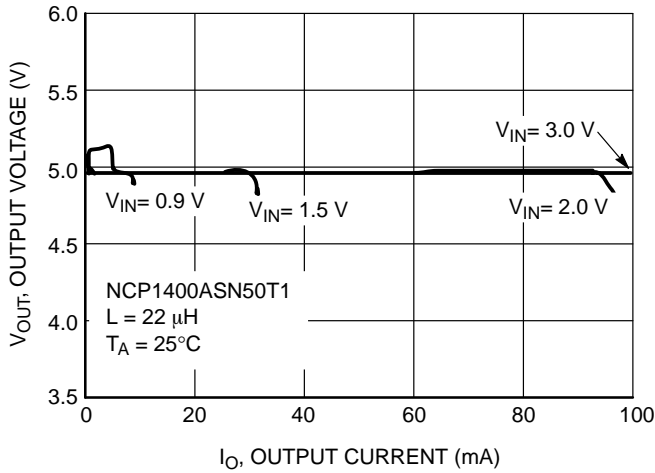
# NCP1400A



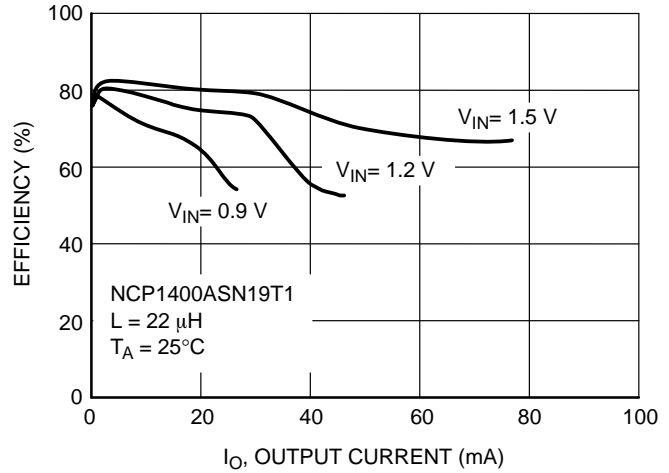
**Figure 2. NCP1400ASN19T1 Output Voltage vs. Output Current**



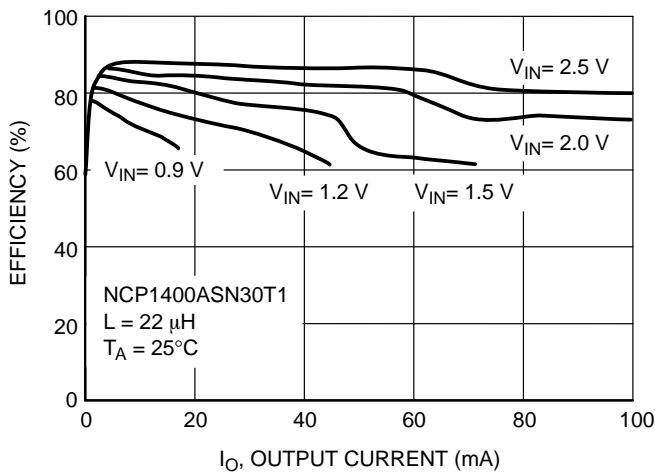
**Figure 3. NCP1400ASN30T1 Output Voltage vs. Output Current**



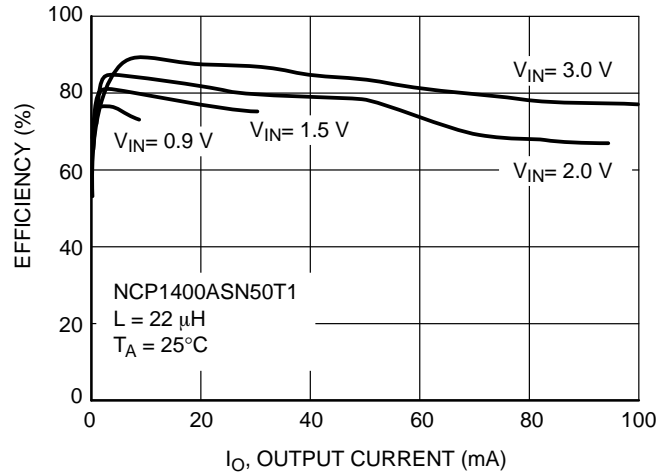
**Figure 4. NCP1400ASN50T1 Output Voltage vs. Output Current**



**Figure 5. NCP1400ASN19T1 Efficiency vs. Output Current**

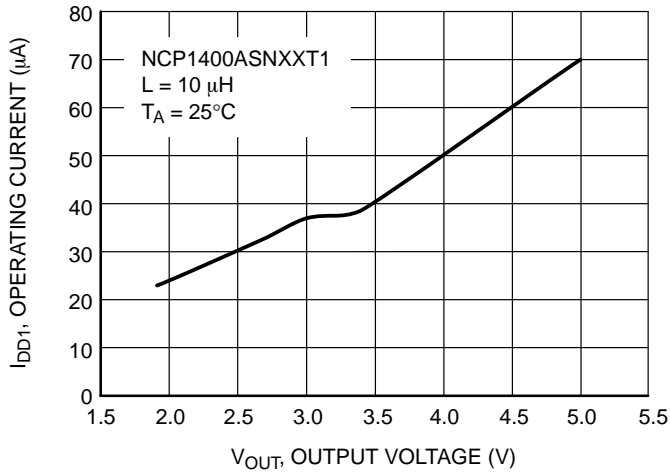


**Figure 6. NCP1400ASN30T1 Efficiency vs. Output Current**

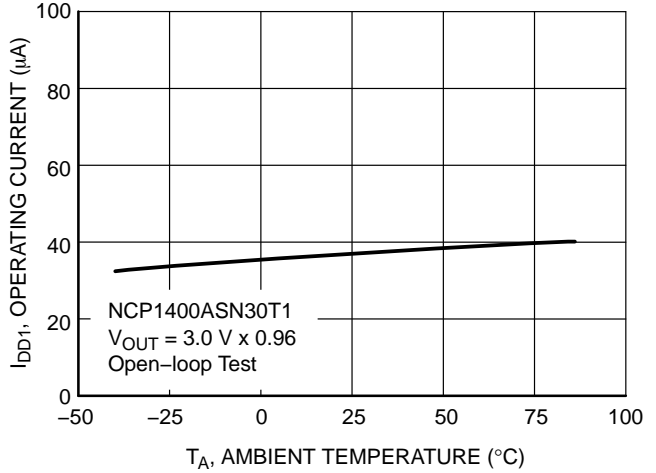


**Figure 7. NCP1400ASN50T1 Efficiency vs. Output Current**

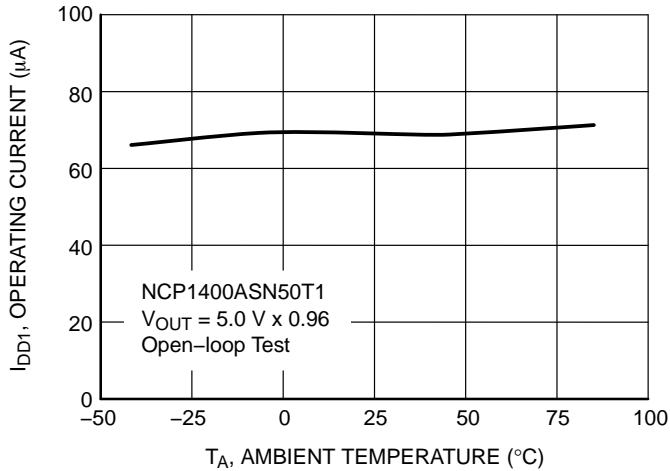
# NCP1400A



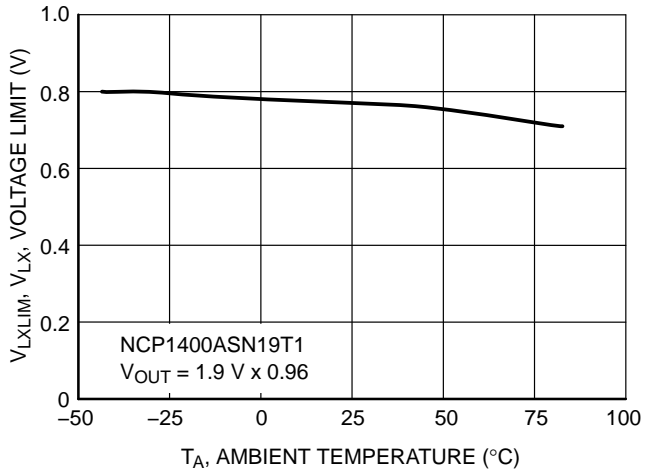
**Figure 8. NCP1400ASNXXT1 Operating Current ( $I_{DD1}$ ) vs. Output Voltage**



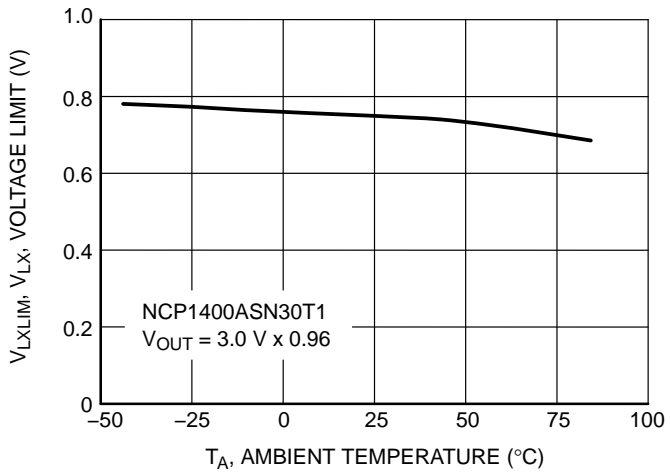
**Figure 9. NCP1400ASN30T1 Current Consumption vs. Temperature**



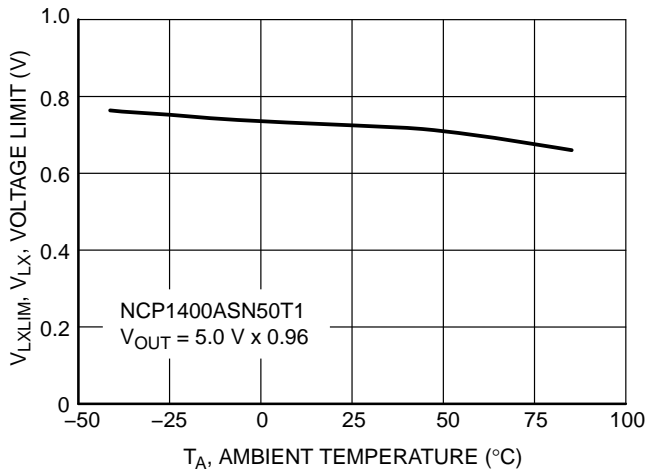
**Figure 10. NCP1400ASN50T1 Current Consumption vs. Temperature**



**Figure 11. NCP1400ASN19T1  $V_{LX}$  Voltage Limit vs. Temperature**

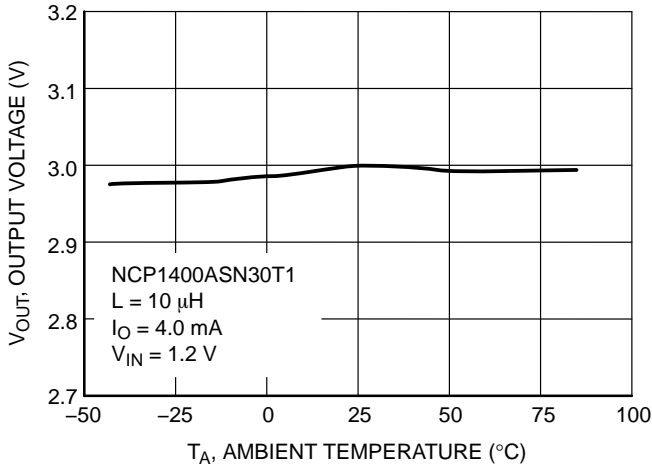


**Figure 12. NCP1400ASN30T1  $V_{LX}$  Voltage Limit vs. Temperature**

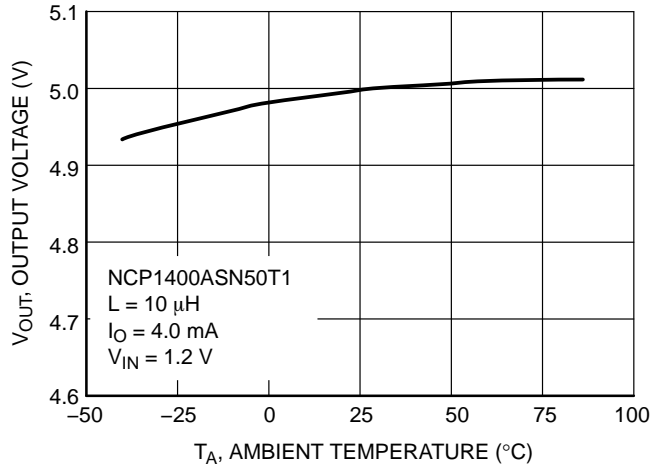


**Figure 13. NCP1400ASN50T1  $V_{LX}$  Voltage Limit vs. Temperature**

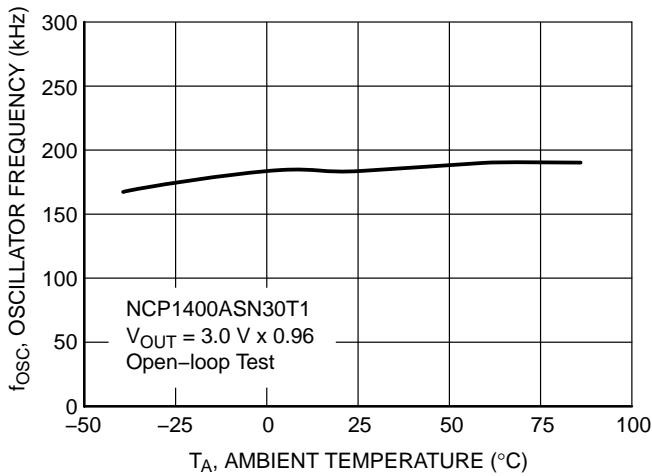
# NCP1400A



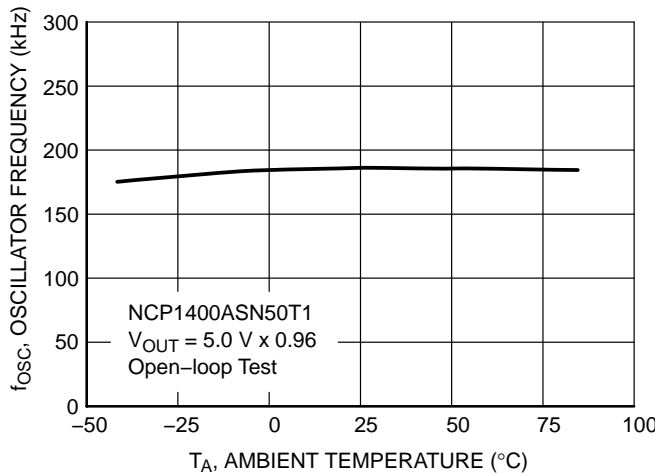
**Figure 14. NCP1400ASN30T1 Output Voltage vs. Temperature**



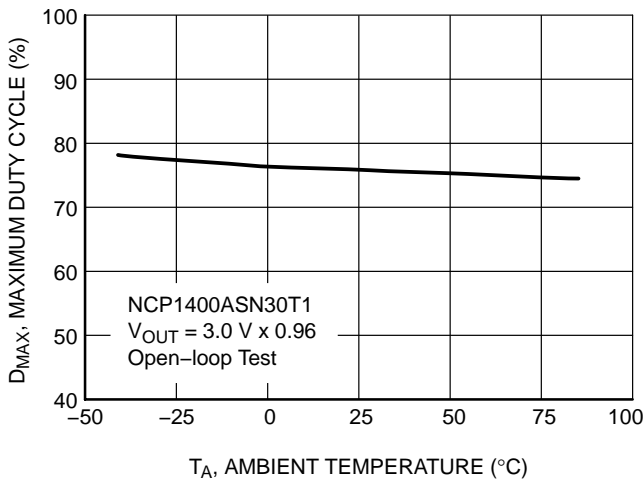
**Figure 15. NCP1400ASN50T1 Output Voltage vs. Temperature**



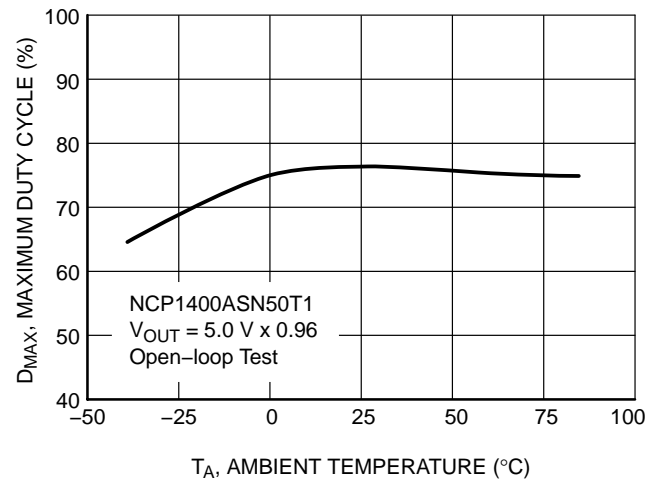
**Figure 16. NCP1400ASN30T1 Oscillator Frequency vs. Temperature**



**Figure 17. NCP1400ASN50T1 Oscillator Frequency vs. Temperature**

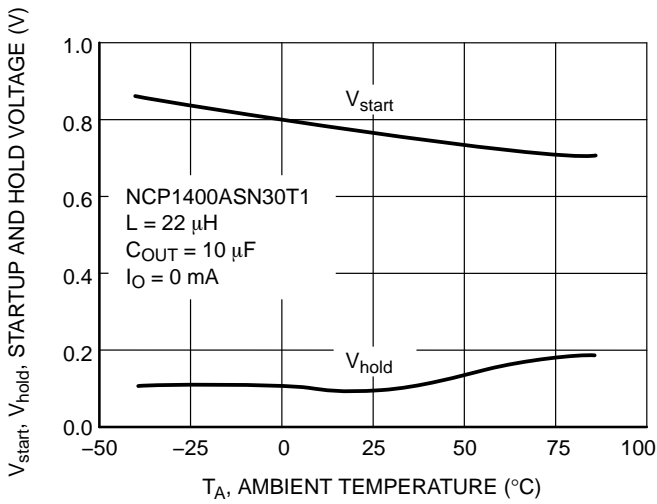


**Figure 18. NCP1400ASN30T1 Maximum Duty Cycle vs. Temperature**

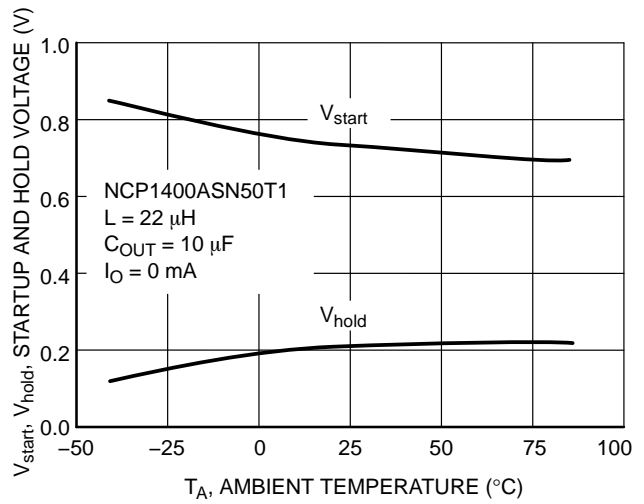


**Figure 19. NCP1400ASN50T1 Maximum Duty Cycle vs. Temperature**

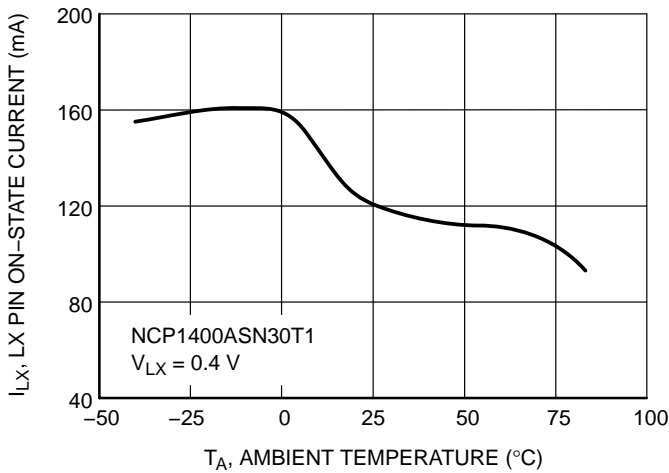
# NCP1400A



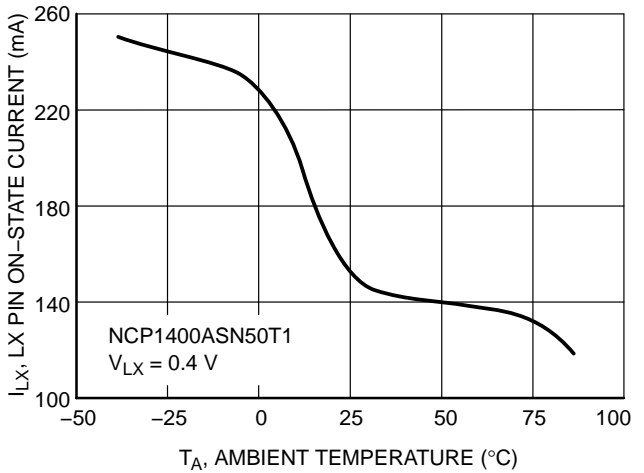
**Figure 20. NCP1400ASN30T1 Startup/Hold Voltage vs. Temperature**



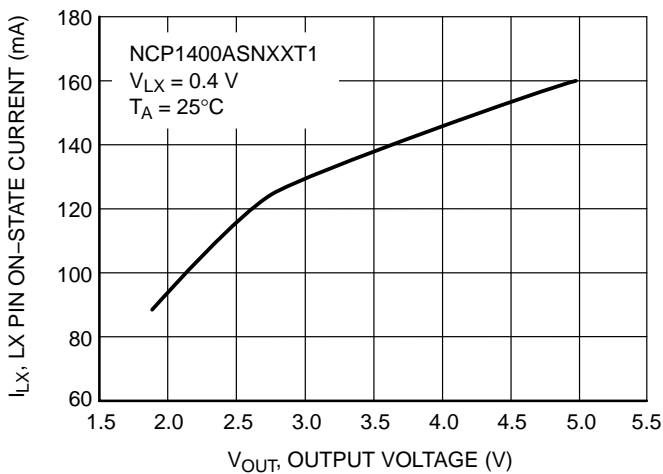
**Figure 21. NCP1400ASN50T1 Startup/Hold Voltage vs. Temperature**



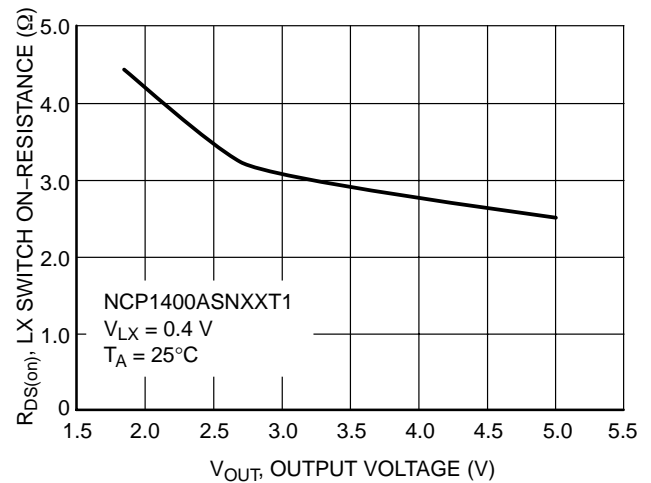
**Figure 22. NCP1400ASN30T1 LX Pin On-State Current vs. Temperature**



**Figure 23. NCP1400ASN50T1 LX Pin On-State Current vs. Temperature**



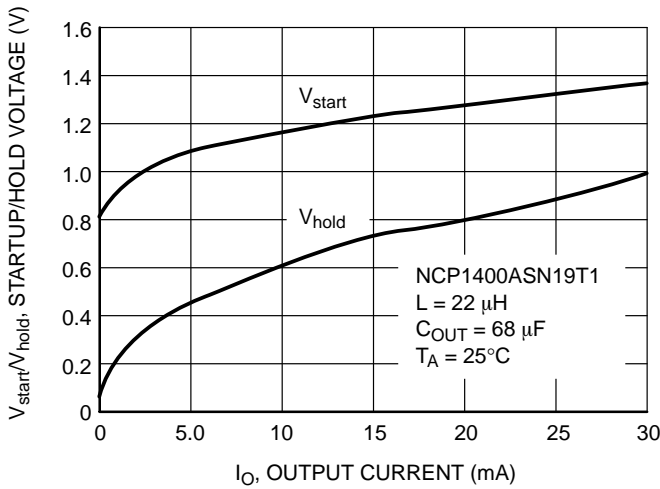
**Figure 24. NCP1400ASNXXT1 LX Pin On-State Current vs. Output Voltage**



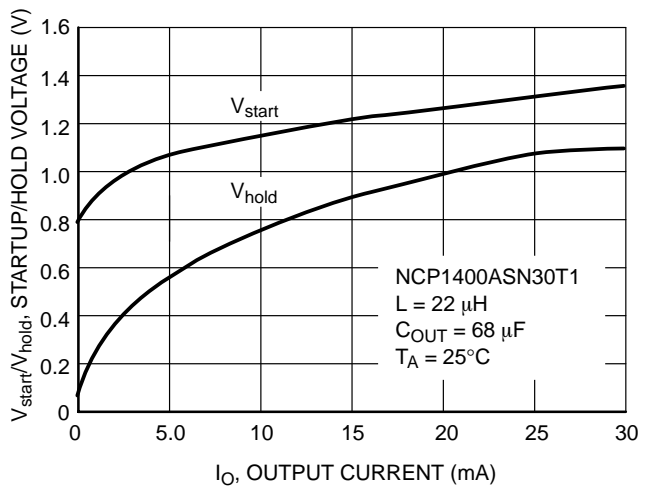
**Figure 25. NCP1400ASNXXT1 LX Switch On-Resistance vs. Output Voltage**



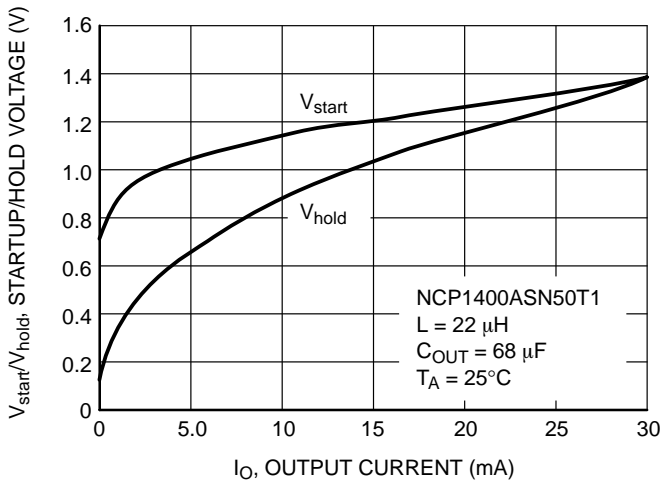
# NCP1400A



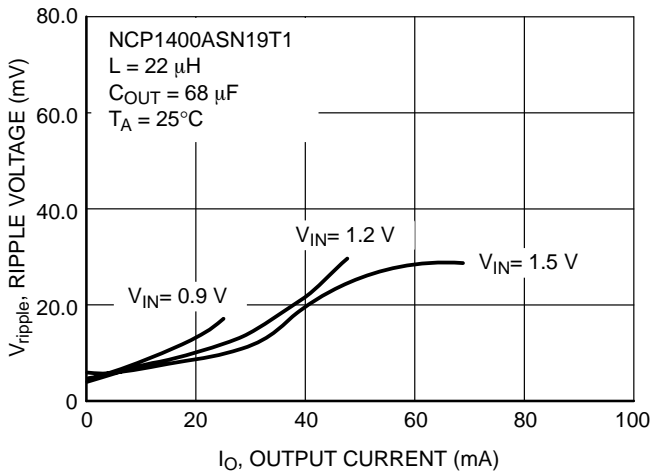
**Figure 26. NCP1400ASN19T1 Operation Startup/Hold Voltage vs. Output Current**



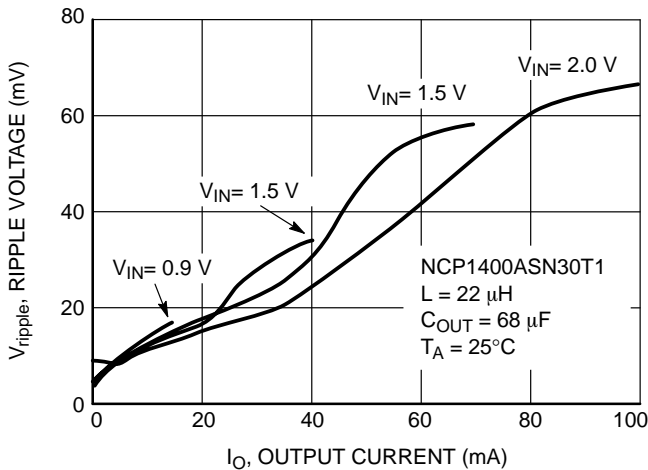
**Figure 27. NCP1400ASN30T1 Operation Startup/Hold Voltage vs. Output Current**



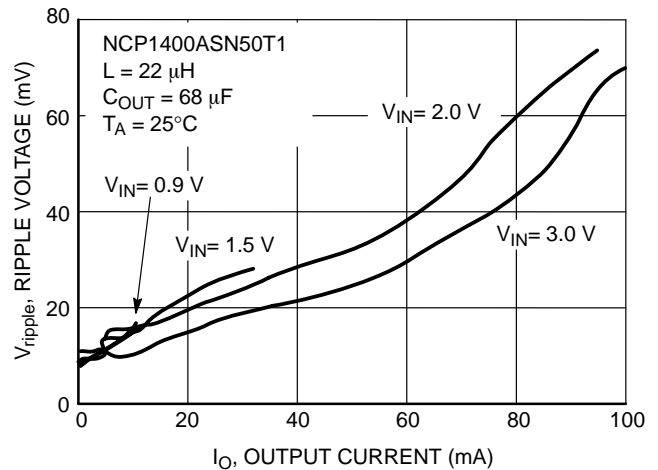
**Figure 28. NCP1400ASN50T1 Operation Startup/Hold Voltage vs. Output Current**



**Figure 29. NCP1400ASN19T1 Ripple Voltage vs. Output Current**

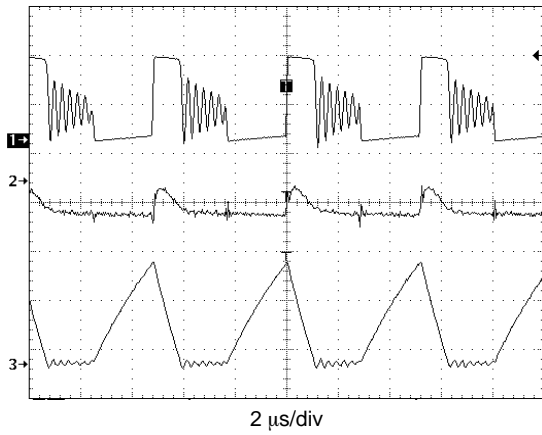


**Figure 30. NCP1400ASN30T1 Ripple Voltage vs. Output Current**



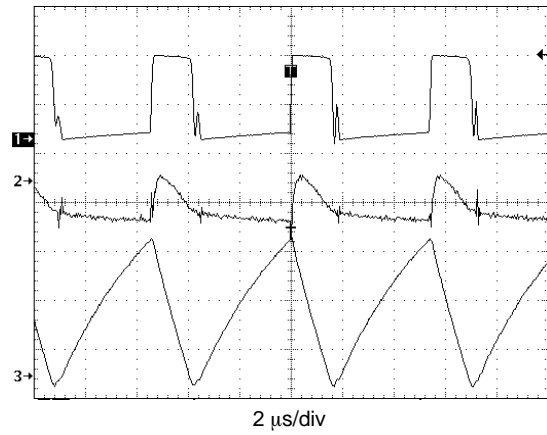
**Figure 31. NCP1400ASN50T1 Ripple Voltage vs. Output Current**

# NCP1400A



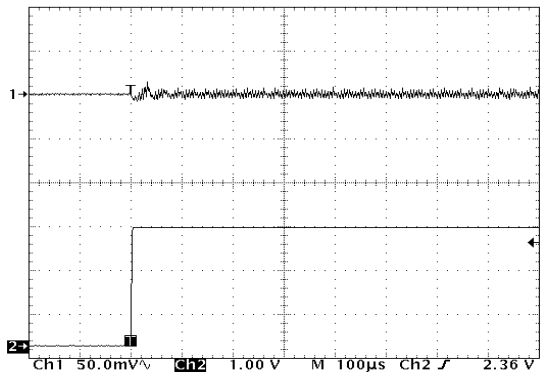
$V_{OUT} = 3.0\text{ V}$ ,  $V_{IN} = 1.2\text{ V}$ ,  $I_O = 10\text{ mA}$ ,  $L = 22\text{ }\mu\text{H}$ ,  $C_{OUT} = 68\text{ }\mu\text{F}$   
 1.  $V_{LX}$ , 2.0 V/div  
 2.  $V_{OUT}$ , 20 mV/div, AC coupled  
 3.  $I_L$ , 100 mA/div

**Figure 32. Operating Waveforms (Medium Load)**



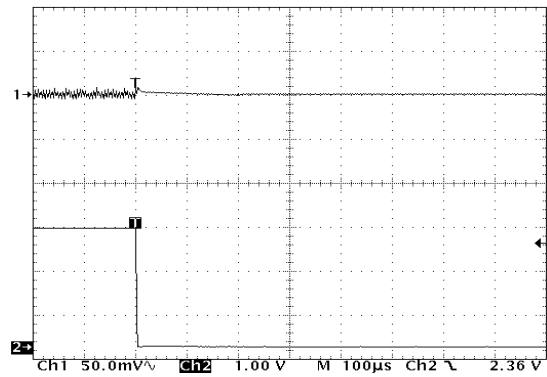
$V_{OUT} = 3.0\text{ V}$ ,  $V_{IN} = 1.2\text{ V}$ ,  $I_O = 25\text{ mA}$ ,  $L = 22\text{ }\mu\text{H}$ ,  $C_{OUT} = 68\text{ }\mu\text{F}$   
 1.  $V_{LX}$ , 2.0 V/div  
 2.  $V_{OUT}$ , 20 mV/div, AC coupled  
 3.  $I_L$ , 100 mA/div

**Figure 33. Operating Waveforms (Heavy Load)**



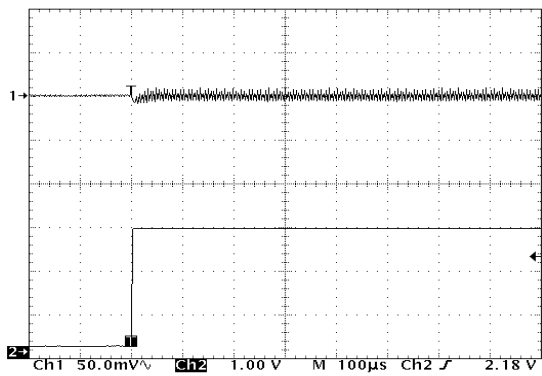
$V_{IN} = 1.2\text{ V}$ ,  $L = 22\text{ }\mu\text{H}$   
 1.  $V_{OUT} = 1.9\text{ V}$  (AC coupled), 50 mV/div  
 2.  $I_O = 3.0\text{ mA}$  to 30 mA

**Figure 34. NCP1400ASN19T1 Load Transient Response**



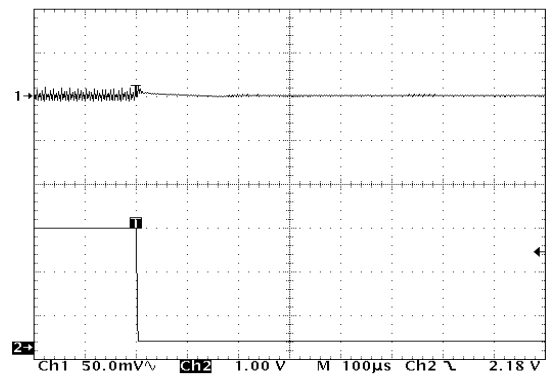
$V_{IN} = 1.2\text{ V}$ ,  $L = 22\text{ }\mu\text{H}$   
 1.  $V_{OUT} = 1.9\text{ V}$  (AC coupled), 50 mV/div  
 2.  $I_O = 30\text{ mA}$  to 3.0 mA

**Figure 35. NCP1400ASN19T1 Load Transient Response**



$V_{IN} = 1.5\text{ V}$ ,  $L = 22\text{ }\mu\text{H}$   
 1.  $V_{OUT} = 3.0\text{ V}$  (AC coupled), 50 mV/div  
 2.  $I_O = 3.0\text{ mA}$  to 30 mA

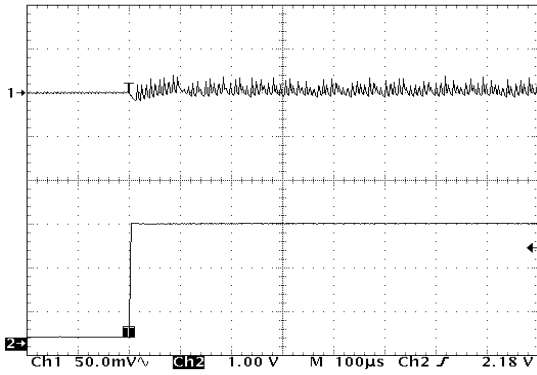
**Figure 36. NCP1400ASN30T1 Load Transient Response**



$V_{IN} = 1.5\text{ V}$ ,  $L = 22\text{ }\mu\text{H}$   
 1.  $V_{OUT} = 3.0\text{ V}$  (AC coupled), 50 mV/div  
 2.  $I_O = 30\text{ mA}$  to 3.0 mA

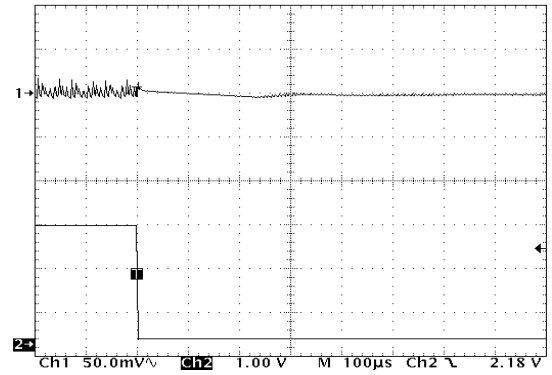
**Figure 37. NCP1400ASN30T1 Load Transient Response**

# NCP1400A



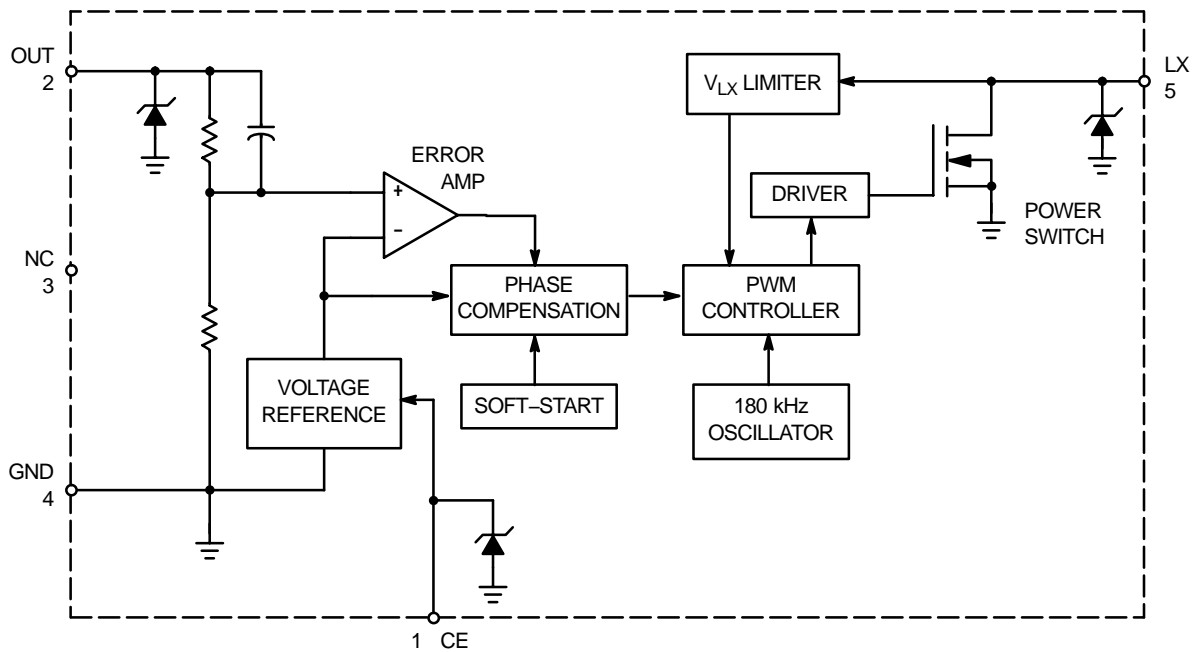
$V_{IN} = 1.5 \text{ V}$ ,  $L = 22 \mu\text{H}$   
 1.  $V_{OUT} = 5.0 \text{ V}$  (AC coupled), 50 mV/div  
 2.  $I_O = 3.0 \text{ mA}$  to 30 mA

**Figure 38. NCP1400ASN50T1  
 Load Transient Response**



$V_{IN} = 1.5 \text{ V}$ ,  $L = 22 \mu\text{H}$   
 1.  $V_{OUT} = 5.0 \text{ V}$  (AC coupled), 50 mV/div  
 2.  $I_O = 30 \text{ mA}$  to 3.0 mA

**Figure 39. NCP1400ASN50T1  
 Load Transient Response**



**Figure 40. Representative Block Diagram**

## PIN FUNCTION DESCRIPTION

Pin #	Symbol	Pin Description
1	CE	Chip Enable Pin (1) The chip is enabled if a voltage equal to or greater than 0.9 V is applied. (2) The chip is disabled if a voltage less than 0.3 V is applied. (3) The chip is enabled if this pin is left floating.
2	OUT	Output voltage monitor pin and also the power supply pin for the device.
3	NC	No internal connection to this pin.
4	GND	Ground pin.
5	LX	External inductor connection pin to power switch drain.

## DETAILED OPERATING DESCRIPTION

### Operation

The NCP1400A series are monolithic power switching regulators optimized for applications where power drain must be minimized. These devices operate as fixed frequency, voltage mode boost regulator and is designed to operate in the discontinuous conduction mode. Potential applications include low powered consumer products and battery powered portable products.

The NCP1400A series are low noise fixed frequency voltage-mode PWM DC-DC converters, and consist of soft-start circuit, feedback resistor, reference voltage, oscillator, loop compensation network, PWM control circuit, current limit circuit and power switch. Due to the on-chip feedback resistor and loop compensation network, the system designer can get the regulated output voltage from 1.8 V to 5.0 V with a small number of external components. The quiescent current is typically 32  $\mu\text{A}$  ( $V_{\text{OUT}} = 2.7 \text{ V}$ ), and can be further reduced to about 1.5  $\mu\text{A}$  when the chip is disabled ( $V_{\text{CE}} < 0.3 \text{ V}$ ).

### Soft-Start

There is a soft-start circuit in NCP1400A. When power is applied to the device, the soft-start circuit pumps up the output voltage to approximately 1.5 V at a fixed duty cycle, the level at which the converter can operate normally. What is more, the startup capability with heavy loads is also improved.

### Oscillator

The oscillator frequency is internally set to 180 kHz at an accuracy of  $\pm 20\%$  and with low temperature coefficient of 0.11%/°C. Figures 16 and 17 illustrate oscillator frequency versus temperature.

### Regulated Converter Voltage ( $V_{\text{OUT}}$ )

The  $V_{\text{OUT}}$  is set by an internal feedback resistor network. This is trimmed to a selected voltage from 1.8 V to 5.0 V range in 100 mV steps with an accuracy of  $\pm 2.5\%$ . Note: When the duty cycle is less than about 12%, the regulator will skip switching cycles to maintain high efficiency at light loads. The regulated output will be raised by 3 to 4% under this condition.

### Compensation

The device is designed to operate in discontinuous conduction mode. An internal compensation circuit was designed to guarantee stability over the full input/output voltage and full output load range. Stability cannot be guaranteed in continuous conduction mode.

### Current Limit

The NCP1400A series utilizes cycle-by-cycle current limiting as a means of protecting the output switch MOSFET from overstress and preventing the small value inductor from saturation. Current limiting is implemented by monitoring the output MOSFET current build-up during conduction, and upon sensing an overcurrent conduction immediately turning off the switch for the duration of the oscillator cycle.

The voltage across the output MOSFET is monitored and compared against a reference by the VLX limiter. When the threshold is reached, a signal is sent to the PWM controller block to terminate the output switch conduction. The current limit threshold is typically set at 350 mA.

### Enable/Disable Operation

The NCP1400A series offer IC shutdown mode by chip enable pin (CE pin) to reduce current consumption. An internal 150 nA pull-up current source tied the CE pin to OUT pin by default, i.e., user can float the pin CE for permanent "On". When voltage at pin CE is equal or greater than 0.9 V, the chip will be enabled, which means the regulator is in normal operation. When voltage at pin CE is less than 0.3 V, the chip is disabled, which means IC is shutdown.

**Important: DO NOT apply a voltage between 0.3 V to 0.9 V to pin CE as this voltage will place the IC into an undefined state and the IC may drain excessive current from the supply.**

# NCP1400A

## APPLICATION CIRCUIT INFORMATION

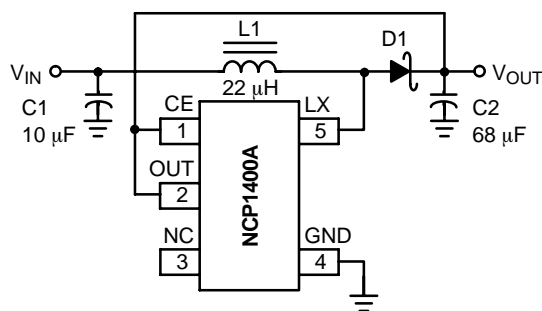


Figure 41. Typical Step-Up Converter Application

### Step-up Converter Design Equations

General step-up DC-DC converter designed to operate in discontinuous conduction mode can be defined by:

Calculation	Equation
D	$\frac{t_{on}}{T}$
$I_{PK}$	$\frac{V_{in} t_{on}}{L}$
$I_O$	$\frac{(V_{in})^2 (t_{on})^2 f}{2L(V_{out} + V_F - V_{in})}$

- D – Duty cycle
  - $I_{PK}$  – Peak inductor current
  - $I_O$  – Desired dc output current
  - $V_{IN}$  – Nominal operating dc input voltage
  - $V_{OUT}$  – Desired dc output voltage
  - $V_F$  – Diode forward voltage
- Assume saturation voltage of the internal FET switch is negligible.

### External Component Selection

#### Inductor

Inductance values between 18  $\mu$ H and 27  $\mu$ H are the best suitable values for NCP1400A. In general, smaller inductance values can provide larger peak inductor current and output current capability, and lower conversion efficiency, and vice versa. Select an inductor with smallest possible DCR, usually less than 1.0  $\Omega$ , to minimize loss. It is necessary to choose an inductor with saturation current greater than the peak current which the inductor will encounter in the application. The inductor selected should be able to handle the worst case peak inductor current without saturation.

#### Diode

The diode is the largest source of loss in DC-DC converters. The most importance parameters which affect their efficiency are the forward voltage drop,  $V_F$ , and the reverse recovery time,  $t_{rr}$ . The forward voltage drop creates a loss just by having a voltage across the device while a current flowing through it. The reverse recovery time generates a loss when the diode is reverse biased, and the current appears to actually flow backwards through the diode due to the minority carriers being swept from the P-N junction. A Schottky diode with the following characteristics is recommended:

- Small forward voltage,  $V_F < 0.3$  V
- Small reverse leakage current
- Fast reverse recovery time/switching speed
- Rated current larger than peak inductor current,  $I_{rated} > I_{PK}$
- Reverse voltage larger than output voltage,  $V_{reverse} > V_{OUT}$

#### Input Capacitor

The input capacitor can stabilize the input voltage and minimize peak current ripple from the source. The value of the capacitor depends on the impedance of the input source used. Small Equivalent Series Resistance (ESR) Tantalum or ceramic capacitor with value of 10  $\mu$ F should be suitable.

#### Output Capacitor

The output capacitor is used for sustaining the output voltage when the internal MOSFET is switched on and smoothing the ripple voltage. Low ESR capacitor should be used to reduce output ripple voltage. In general, a 47  $\mu$ F to 68  $\mu$ F low ESR (0.15  $\Omega$  to 0.30  $\Omega$ ) Tantalum capacitor should be appropriate.

# NCP1400A

An evaluation board of NCP1400A has been made in the small size of 23 mm x 20 mm and is shown in Figures 42 and 43. Please contact your ON Semiconductor

representative for availability. The evaluation board schematic diagram, the artwork and the silkscreen of the surface mount PCB are shown below:

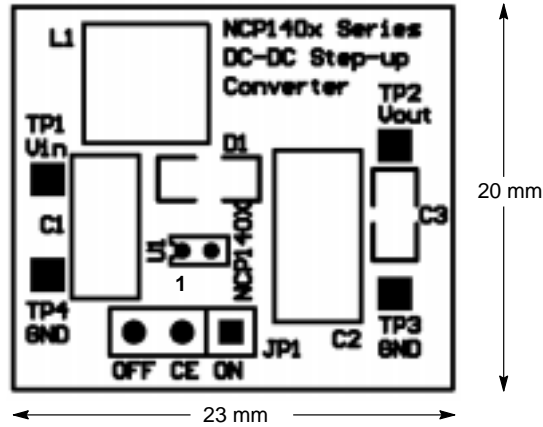


Figure 42. NCP1400A PWM Step-up DC-DC Converter Evaluation Board Silkscreen

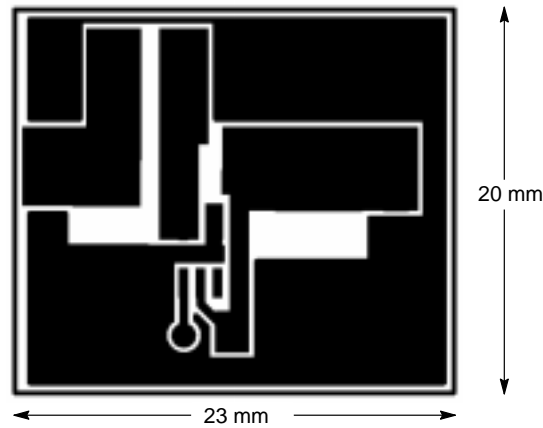


Figure 43. NCP1400A PWM Step-up DC-DC Converter Evaluation Board Artwork (Component Side)

# NCP1400A

## Components Supplier

Parts	Supplier	Part Number	Description	Phone
Inductor, L1	Sumida Electric Co. Ltd.	CR54-220MC	Inductor 22 $\mu$ H/1.11 A	(852) 2880-6688
Schottky Diode, D1	ON Semiconductor Corp.	MBR0520LT1	Schottky Power Rectifier	(852) 2689-0088
Output Capacitor, C2	KEMET Electronics Corp.	T494D686K010AS	Low ESR Tantalum Capacitor 68 $\mu$ F/10 V	(852) 2305-1168
Input Capacitor, C1	KEMET Electronics Corp.	T491C106K016AS	Low Profile Tantalum Capacitor 10 $\mu$ F/16 V	(852) 2305-1168

## PCB Layout Hints

### Grounding

One point grounding should be used for the output power return ground, the input power return ground, and the device switch ground to reduce noise as shown in Figure 44, e.g.: C2 GND, C1 GND, and U1 GND are connected at one point in the evaluation board. The input ground and output ground traces must be thick enough for current to flow through and for reducing ground bounce.

### Power Signal Traces

Low resistance conducting paths should be used for the power carrying traces to reduce power loss so as to improve

efficiency (short and thick traces for connecting the inductor L can also reduce stray inductance), e.g. short and thick traces listed below are used in the evaluation board:

1. Trace from TP1 to L1
2. Trace from L1 to Lx pin of U1
3. Trace from L1 to anode pin of D1
4. Trace from cathode pin of D1 to TP2

### Output Capacitor

The output capacitor should be placed close to the output terminals to obtain better smoothing effect on the output ripple.

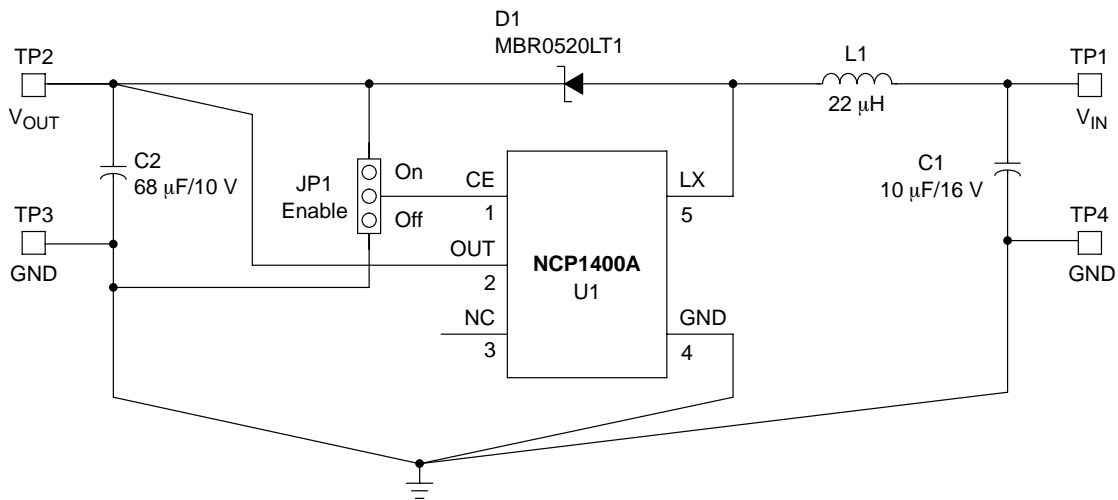
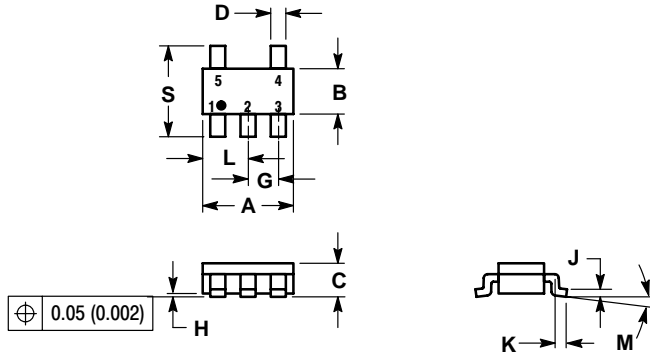


Figure 44. NCP1400A Evaluation Board Schematic Diagram

# NCP1400A

## PACKAGE DIMENSIONS

THIN SOT23-5  
SN SUFFIX  
CASE 483-02  
ISSUE C

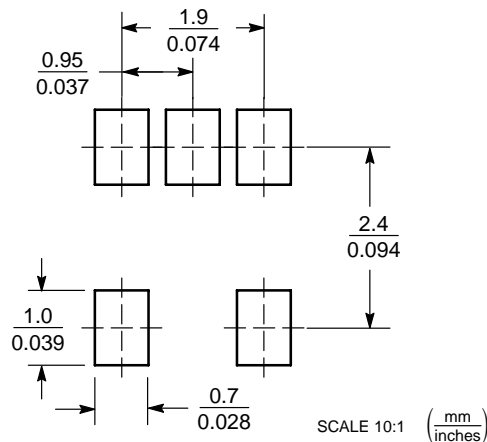


### NOTES:


1. DIMENSIONING AND TOLERANCING PER ANSI Y14.5M, 1982.
2. CONTROLLING DIMENSION: MILLIMETER.
3. MAXIMUM LEAD THICKNESS INCLUDES LEAD FINISH THICKNESS. MINIMUM LEAD THICKNESS IS THE MINIMUM THICKNESS OF BASE MATERIAL.
4. A AND B DIMENSIONS DO NOT INCLUDE MOLD FLASH, PROTRUSIONS, OR GATE BURRS.

DIM	MILLIMETERS		INCHES	
	MIN	MAX	MIN	MAX
A	2.90	3.10	0.1142	0.1220
B	1.30	1.70	0.0512	0.0669
C	0.90	1.10	0.0354	0.0433
D	0.25	0.50	0.0098	0.0197
G	0.85	1.05	0.0335	0.0413
H	0.013	0.100	0.0005	0.0040
J	0.10	0.26	0.0040	0.0102
K	0.20	0.60	0.0079	0.0236
L	1.25	1.55	0.0493	0.0610
M	0	10	0	10
S	2.50	3.00	0.0985	0.1181

### SOLDERING FOOTPRINT\*



\*For additional information on our Pb-Free strategy and soldering details, please download the ON Semiconductor Soldering and Mounting Techniques Reference Manual, SOLDERRM/D.

ON Semiconductor and  are registered trademarks of Semiconductor Components Industries, LLC (SCILLC). SCILLC reserves the right to make changes without further notice to any products herein. SCILLC makes no warranty, representation or guarantee regarding the suitability of its products for any particular purpose, nor does SCILLC assume any liability arising out of the application or use of any product or circuit, and specifically disclaims any and all liability, including without limitation special, consequential or incidental damages. "Typical" parameters which may be provided in SCILLC data sheets and/or specifications can and do vary in different applications and actual performance may vary over time. All operating parameters, including "Typicals" must be validated for each customer application by customer's technical experts. SCILLC does not convey any license under its patent rights nor the rights of others. SCILLC products are not designed, intended, or authorized for use as components in systems intended for surgical implant into the body, or other applications intended to support or sustain life, or for any other application in which the failure of the SCILLC product could create a situation where personal injury or death may occur. Should Buyer purchase or use SCILLC products for any such unintended or unauthorized application, Buyer shall indemnify and hold SCILLC and its officers, employees, subsidiaries, affiliates, and distributors harmless against all claims, costs, damages, and expenses, and reasonable attorney fees arising out of, directly or indirectly, any claim of personal injury or death associated with such unintended or unauthorized use, even if such claim alleges that SCILLC was negligent regarding the design or manufacture of the part. SCILLC is an Equal Opportunity/Affirmative Action Employer. This literature is subject to all applicable copyright laws and is not for resale in any manner.

### PUBLICATION ORDERING INFORMATION

#### LITERATURE FULFILLMENT:

Literature Distribution Center for ON Semiconductor  
P.O. Box 61312, Phoenix, Arizona 85082-1312 USA

Phone: 480-829-7710 or 800-344-3860 Toll Free USA/Canada

Fax: 480-829-7709 or 800-344-3867 Toll Free USA/Canada

Email: orderlit@onsemi.com

N. American Technical Support: 800-282-9855 Toll Free  
USA/Canada

Japan: ON Semiconductor, Japan Customer Focus Center  
2-9-1 Kamimeguro, Meguro-ku, Tokyo, Japan 153-0051  
Phone: 81-3-5773-3850

ON Semiconductor Website: <http://onsemi.com>

Order Literature: <http://www.onsemi.com/litorder>

For additional information, please contact your local Sales Representative.